

6360 is a miniature type RF power tube which can be used for frequencies of up to 200 Mc.

This tube is most suitable for use in mobile wireless equipment.

BASE E9-1 Small Button Noval 9-Pin

MOUNTING POSITION—Vertical, or Horizontal
with Pins 2 and 7 Vertical Plans.

HEATER	Series	Parallel
Voltage.....	12.6	6.3 (V)
Current	0.41	0.82 (A)

DIRECT INTERELECTRODE CAPACITANCES

(Without Shield)	Each Unit	Push-Pull
Grid No. 1 to Plate	0.1 max.	— (pF)
Input	6.2	5.1 (pF)
Output	2.6	1.4 (pF)

CHARACTERISTICS

Transconductance ($I_b=30$ mA)	3,300 ($\mu\Omega$)
Amplification Factor (G_1 to G_2 , $I_b=30$ mA)	7.5

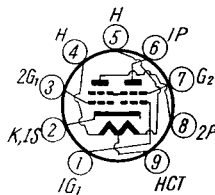
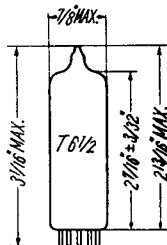

NOTE

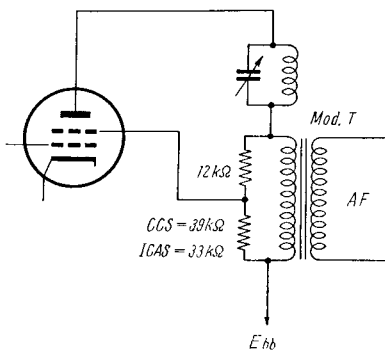

MAXIMUM RATINGS (Absolute Maximum Values, CCS)§

	AF. Power Amplifier	Class C (200Mc) Telegraphy	Class* C (200Mc) Telephony	Frequency (66.6/200Mc) Tripler
Plate Voltage	300	300	240	300 (V)
Grid No. 2 Voltage	200	200	200	200 (V)
Negative D.C. Grid No. 1 Voltage	-150	-150	-150	-150 (V)
Plate Dissipation	7	5	3.3	5 (W)
Grid No. 2 Dissipation	1	1	—	— (W)
Grid No. 1 Dissipation	0.2	0.2	—	— (W)
Plate Input	—	11.25	7.5	7.5 (W)
Grid No. 2 Input	—	—	0.63	1 (W)
Plate Current	50	45	37.5	30 (mA)
Grid No. 2 Current	15	—	—	— (mA)
Grid No. 1 Current	4	3	3	2 (mA)
Peak Cathode Current	300	225	180	225 (mA)
Total Cathode Current	60	50	40	35 (mA)
Peak Heater—Cathode Voltage				
Heater negative with respect to cathode	100	100	100	100 (V)
Heater positive with respect to cathode	100	100	100	100 (V)
Grid No. 1 Circuit Resistance	100	—	—	— (kΩ)

§ Each unit

* Plate and grid No. 2 modulation.

TYPICAL OPERATION (Push-Pull Operation)

	Class C (200Mc) Telegraphy		Class* C (200Mc) Telephony		Frequency (66.6/200Mc) Tripler	
	CCS	ICAS	CCS	ICAS	CCS	ICAS
Plate Voltage	300	300	200	200	300	300 (V)
Grid No. 2 Voltage	175	200	Note	Note	150	150 (V)
Grid No. 1 Voltage	-40	-45	—	—	-100	-100 (V)
Grid No. 1 Bias Resistor	—	—	33	15	—	— (kΩ)
Peak RF Grid No. 1 to Grid No. 1 Voltage	110	130	130	130	230	240 (V)
Plate Current	2×37.5	2×50	2×33.5	2×43	2×24	2×32.5 (mA)
Grid No. 2 Current	2.3	3.0	2.6	3.1	2.0	3.5 (mA)
Grid No. 1 Current (Approx.)	1.8	3.0	1.5	3.3	2×1	2×1.9 (mA)
Driving Power (Approx.)	0.1	0.2	0.1	0.2	0.23	0.45 (W)
Power Output (Approx.)	14.5	18.5	8.1	9.8	6.4	7.8 (W)
Efficiency	65	62	60	57	45	40 (%)
Useful Power	12	16	7.1	8.8	3.5	4.8 (W)
Modulation Power (for 100% Modulation)	—	—	6.7	8.6	—	— (W)

* Plate and grid No. 2 modulation

AVERAGE PLATE CHARACTERISTICS
(Each Unit)

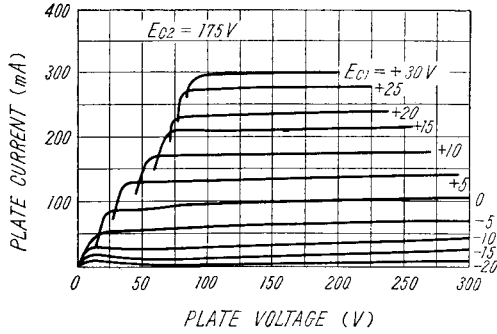

AVERAGE GRID No. 1 CHARACTERISTICS
(Each Unit)

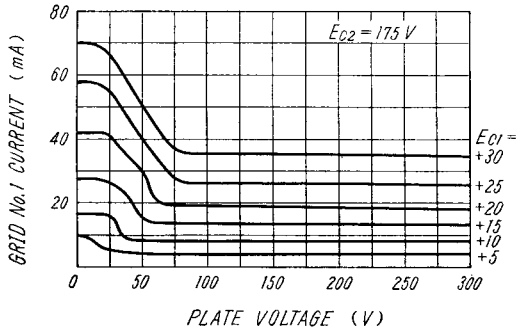

AVERAGE GRID No. 1 CHARACTERISTICS
(Each Unit)

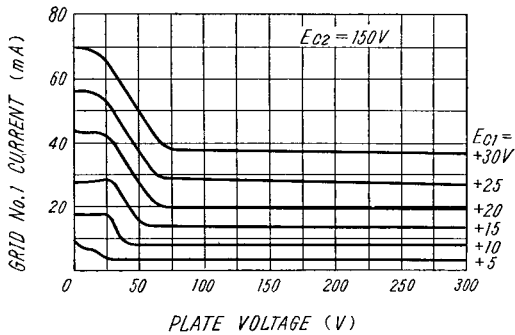

AVERAGE PLATE CHARACTERISTICS
(Each Unit)

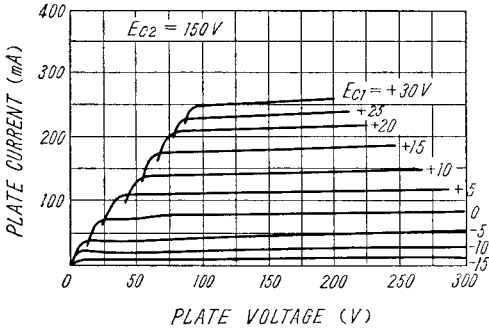

AVERAGE GRID No. 2 CHARACTERISTICS
(Each Unit)

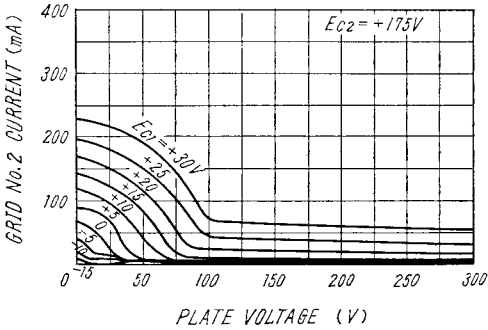

AVERAGE GRID No. 2 CHARACTERISTICS
(Each Unit)

